

# Inverter/Chargers

## Perfect Wave Series

### Models:

- 12-3000IC
- 12-3000IC-DV
- 24-4800IC
- 24-4800IC-DV

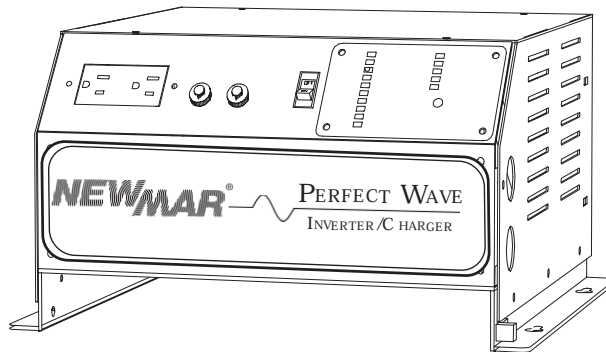

## INSTALLATION/OPERATION MANUAL

### CONTENTS

Section	Topic	Page
I)	OVERVIEW.....	2
II)	IMPORTANT SAFETY CAUTIONS AND WARNINGS.....	3
III)	INSTALLATION.....	3
	A) Materials Provided.....	4
	B) Location.....	4
	C) Mounting.....	4
	D) Case Grounding.....	5
	E) Battery Selection and Sizing.....	5
	F) Battery (DC) Wiring.....	6
	G) Charging Multiple Battery Banks.....	8
	H) Temperature Compensation Sensor.....	9
	I) AC Input Wiring.....	10
	J) AC Output Options.....	11
	K) Remote Panel (optional).....	12
IV)	BATTERY CHARGER OPERATION.....	13
	A) Battery Capacity Selector.....	13
	B) Charger Output Selector.....	14
	C) Battery Charging Cycle Explained.....	15
V)	INVERTER OPERATION.....	18
	A) Start-Up/Operation.....	17
	B) Inverter ON/OFF Switch Functions.....	18
	C) Inverter Auto-Shut-down Indicators/Causes.....	19
VI)	SPECIFICATIONS.....	20
VII)	BATTERY CARE TIPS.....	22
VIII)	REFERENCE APPENDIX.....	24

M-IC3  
Jan 2006

1



**ELECTRONIC POWER PRODUCTS**  
**COMMUNICATION • NAVIGATION**

[www.newmarpower.com](http://www.newmarpower.com)

P.O. Box 1306  
Newport Beach,  
California 92663

Phone: 714-751-0488  
Fax: 714-957-1621  
E-Mail: [sales@newmarpower.com](mailto:sales@newmarpower.com)

## D    OVERVIEW

Your NEWMAR Inverter/Charger uses 12 or 24 VDC (depending on model) battery power to produce 115 VAC or 115/230 VAC (DV models), 60 Hz power for operating virtually any AC appliance. It incorporates field-proven technology which provides reliable service in harsh commercial and recreational marine applications.

These **Perfect Wave** series inverter/chargers produce pure sinusoidal AC for flawless operation of all appliances, including highly sensitive electronics such as computers, stereos and video displays which are intolerant to any AC wave distortion.

Both models incorporate a built-in three stage battery charger for rapid and safe replenishment of batteries whenever shore or generator AC power is available.

They also feature numerous circuit and safety protections, such as thermally controlled cooling fans and ground fault protected duplex outlets, utilizes an automatic AC transfer relay and is housed in a rugged, rust-resistant powder-coated aluminum case suitable for permanent bulkhead or horizontal mounting. An optional remote indicator and control panel (model ICR-2) is available, as well.

In addition, your Inverter/Charger is UL listed and warranted for two full years, parts and labor. Careful attention to these instructions should enable you to enjoy many years of trouble-free service.

**Figure 1: Quick Reference Contents**

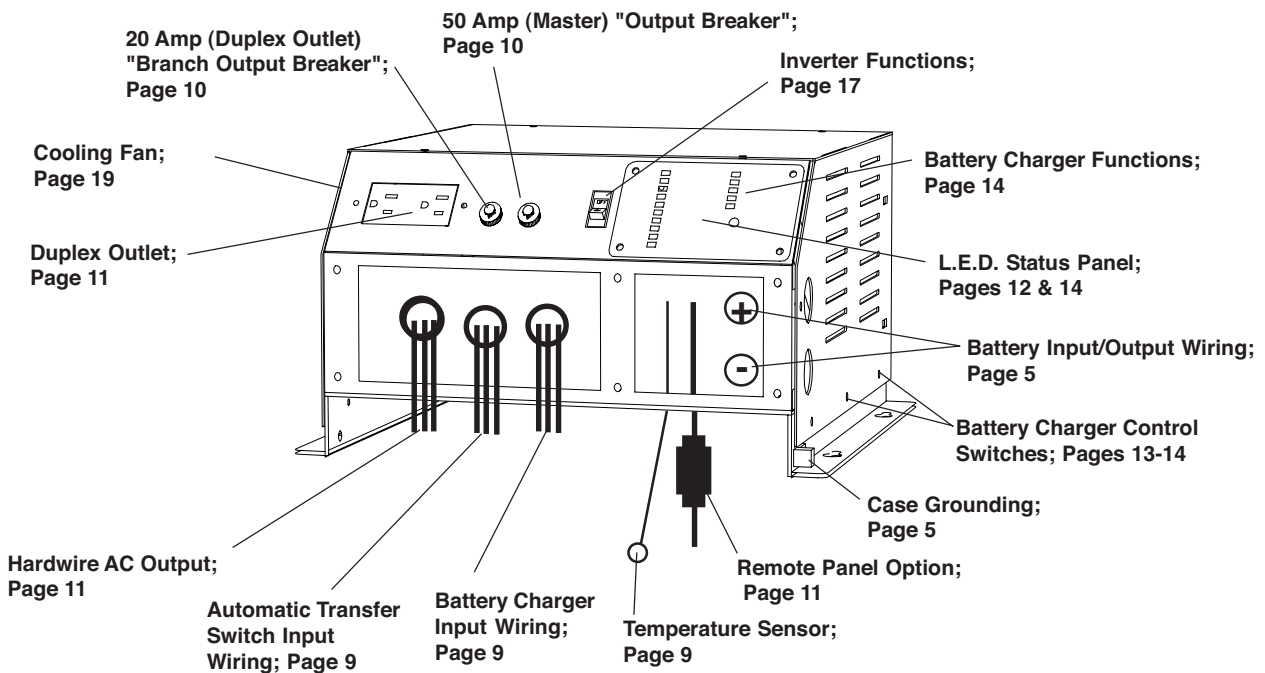

## A) Materials Provided

The inverter/charger is provided with an installation kit containing the following:

- (1 ea.) Hex wrench, 3/8"
- (1 ea.) Warning label for AC distribution panel
- (1 ea.) Installation/Operation Manual
- (1 ea.) Customer satisfaction/warranty card

Please verify that these items have been included with the packaging. For any missing items, contact the factory. Upon completion of the installation, please fill out the warranty card and return it to the factory. (Be sure to include the serial number of the unit, located on the top of the housing.)

## B) Location

The inverter/charger should be located as close to the batteries as possible, ideally no more than about 4-6 feet. The maximum allowable distance is 20 feet. Do not mount the unit directly over the batteries as battery fumes may cause excessive corrosion. *WARNING: The inverter/charger is not ignition protected so it must not be located in an area containing gasoline engines or the like, nor in any other area where ignition protected equipment is required.* The area should be well ventilated and free from moisture, exhaust manifolds and battery fumes.

Do not locate the unit where water, spray or condensation can occur, as this will shorten its life. It should not be located where there is a possibility of dust or debris being drawn into the unit through the fan. A minimum of 2" clearance around the unit is recommended for proper cooling.

If the inverter/charger is located in an extreme heat area, such as an unventilated engine room, and maximum operating temperature is exceeded, an automatic thermal protection circuit will shut the unit completely off. It will automatically return to service when it has cooled sufficiently, however this thermal cycling will shorten the life of the inverter/charger, so if this condition occurs repeatedly, it should be relocated. For optimum performance and longer life the unit should not be located in an area of high temperature.

## C) Mounting

The inverter/charger may be mounted on either a horizontal or vertical surface; performance will be unaffected by its orientation, however, per UL safety recommendations, when mounted vertically the front panel controls should be facing downward. It may be mounted on either a metal or non-metal surface. Four 1/4" screws (wood or machine screws, depending on mounting surface) with washers are required to secure the unit to the mounting surface.

*For vertical (bulkhead) mounting applications:* Note that, in addition to the four permanent mounting holes in the flanges, there is a hole in each mounting flange which is "keyhole" shaped. This is provided to ease vertical installation. Make a mark on the wall or bulkhead where each of the keyhole slots will be located. Then drive a screw about halfway in at each of these marks. Hang the inverter/charger onto the bulkhead using the "keyhole" slots. Doing this will save you from having to support the unit's weight while you are driving in the four permanent mounting screws. Note: The "keyhole" slots may be used for additional support screws but they are not to be used as a permanent mounting points, by themselves.

*IMPORTANT:* Although the inverter/charger is constructed of materials and in a manner which makes it resistive to the corrosive effects of the marine environment the unit is not waterproof. Do not mount the charger where there is a possibility of water entering the unit. Evidence of water entry into the inverter/charger will void the warranty.



**ELECTRONIC POWER PRODUCTS**  
**COMMUNICATION • NAVIGATION**

[www.newmarpower.com](http://www.newmarpower.com)

3

P.O. Box 1306  
Newport Beach,  
California 92663

Phone: 714-751-0488  
Fax: 714-957-1621  
E-Mail: [sales@newmarpower.com](mailto:sales@newmarpower.com)

## A) Materials Provided

The inverter/charger is provided with an installation kit containing the following:

- (1 ea.) Hex wrench, 3/8"
- (1 ea.) Warning label for AC distribution panel
- (1 ea.) Installation/Operation Manual
- (1 ea.) Customer satisfaction/warranty card

Please verify that these items have been included with the packaging. For any missing items, contact the factory. Upon completion of the installation, please fill out the warranty card and return it to the factory. (Be sure to include the serial number of the unit, located on the top of the housing.)

## B) Location

The inverter/charger should be located as close to the batteries as possible, ideally no more than about 4-6 feet. The maximum allowable distance is 20 feet. Do not mount the unit directly over the batteries as battery fumes may cause excessive corrosion. *WARNING: The inverter/charger is not ignition protected so it must not be located in an area containing gasoline engines or the like, nor in any other area where ignition protected equipment is required.* The area should be well ventilated and free from moisture, exhaust manifolds and battery fumes.

Do not locate the unit where water, spray or condensation can occur, as this will shorten its life. It should not be located where there is a possibility of dust or debris being drawn into the unit through the fan. A minimum of 2" clearance around the unit is recommended for proper cooling.

If the inverter/charger is located in an extreme heat area, such as an unventilated engine room, and maximum operating temperature is exceeded, an automatic thermal protection circuit will shut the unit completely off. It will automatically return to service when it has cooled sufficiently, however this thermal cycling will shorten the life of the inverter/charger, so if this condition occurs repeatedly, it should be relocated. For optimum performance and longer life the unit should not be located in an area of high temperature.

## C) Mounting

The inverter/charger may be mounted on either a horizontal or vertical surface; performance will be unaffected by its orientation, however, per UL safety recommendations, when mounted vertically the front panel controls should be facing downward. It may be mounted on either a metal or non-metal surface. Four 1/4" screws (wood or machine screws, depending on mounting surface) with washers are required to secure the unit to the mounting surface.

*For vertical (bulkhead) mounting applications:* Note that, in addition to the four permanent mounting holes in the flanges, there is a hole in each mounting flange which is "keyhole" shaped. This is provided to ease vertical installation. Make a mark on the wall or bulkhead where each of the keyhole slots will be located. Then drive a screw about halfway in at each of these marks. Hang the inverter/charger onto the bulkhead using the "keyhole" slots. Doing this will save you from having to support the unit's weight while you are driving in the four permanent mounting screws. Note: The "keyhole" slots may be used for additional support screws but they are not to be used as a permanent mounting points, by themselves.



*IMPORTANT:* Although the inverter/charger is constructed of materials and in a manner which makes it resistive to the corrosive effects of the marine environment the unit is not waterproof. Do not mount the charger where there is a possibility of water entering the unit. Evidence of water entry into the inverter/charger will void the warranty.

## **D) Case Grounding**

The case of the inverter/charger *must* be properly grounded to ship's ground\*.

*\*Per ABYC A-20: A DC chassis grounding conductor shall be connected from the case of the battery charger to the engine negative terminal or its bus, and must not be more than one size under that required for the DC current-carrying conductors.*

For example, if the installed battery wiring (see Wire Size Chart in section F) is 2/0 AWG, then the minimum size of the grounding cable is 1/0 AWG. Use stranded copper wire for case grounding. A screw compression lug located on the right-hand side of the unit is provided for attaching the ground wire to the case. The lug accommodates wires up to 1/0 AWG. A flat blade screwdriver is required to tighten the lug.

## **E) Battery Selection and Sizing**

The inverter/charger should only be wired to deep cycle lead-acid batteries of flooded, gel or AGM construction. The battery bank should be a dedicated inverter (or house) bank. It should not be connected to batteries which are designed primarily for engine or generator starting. Those batteries are not designed for repeated deep discharges which are common with inverter operation.

There are quite a number of variables which can influence the proper size of a battery system (expressed as amp-hour capacity) which is used in conjunction with an inverter. Some of these include:

- Battery type
- Discharge rate in relation to amp-hour capacity
- Intermittent or continuous operation
- Ambient temperature
- Time between recharge cycles
- Depth of discharge

No single formula can practically cover all these variables, however, a general calculation may be used which assumes no extraordinary variable (such as very high or low temperatures in the battery environment) to make an educated estimation of the proper battery size. The result can then be adjusted up or down to compensate for unusual circumstances.



**ELECTRONIC POWER PRODUCTS**  
**COMMUNICATION • NAVIGATION**

[www.newmarpower.com](http://www.newmarpower.com)

Use the following procedure to calculate the required amp-hour capacity for your battery system:

*Note: It is assumed that the batteries are a suitable deep-cycle type, that discharge will not exceed 50%, and that batteries will be fully recharged after each cycle of inverter use.*

1) Determine the maximum amount of time in hours that the inverter will run the loads before an external source of AC becomes available and batteries can be fully recharged.

2) Survey all AC appliances and determine how many watt-hours will be consumed by each during that same period. For instance, if a 100 watt TV will be powered for 3 hours, that equals 300 watt-hours. If a 1,500 watt microwave will also be run for half an hour, then that is another 750 watt-hours (i.e.,  $1,500 \times .5$ ). Bear in mind that some loads, such as refrigerators, are intermittent, so an average must be used.

3) Add up the total watt-hour consumption of all appliances, then apply this simple rule to determine total DC (battery) amp-hours consumed:

**12 Volt Inverters: Divide Watt-Hours by 10**

**24 Volt Inverters: Divide Watt-Hours by 20**

*Note: These divisors allow for standard inefficiency during voltage conversion.*

4) Finally, since it is generally recommended that batteries never be discharged below 50%, the result must be multiplied by 2 to obtain the proper total battery capacity.

**Example # 1:** You have a 12 volt inverter. Your total consumption between recharge cycles is 2,400 watt-hours, so...

$$2,400 \div 10 = 240 \text{ (Amp-Hours Consumed)}$$

$$240 \times 2 = 480$$

So, in this example, a properly sized battery system will be rated for at least 480 amp-hours.

**Example # 2:** You have a 24 volt inverter. Your total consumption between recharge cycles is 3,600 watt-hours, so...

$$3,600 \div 20 = 180 \text{ (Amp-Hours Consumed)}$$

$$180 \times 2 = 360$$

In this case, you need a battery system rated for at least 360 amp-hours.

*An Important Note about Amp-Hour Ratings and Discharge Rates:* The amp-hour rating of a battery is typically based on the usable current that could be drawn from the battery over a 20 hour period. For instance, if a battery is rated at 200 amp-hours, this means it would deliver roughly 10 amps for a period of 20 hours. Increasing the discharge rate decreases the total amp-hours the battery can deliver, and this effect becomes more pronounced as the discharge rate approaches the battery capacity. For instance if the same 200 amp-hour battery were subjected to a continuous current draw of 200 amps, it would deliver less than 100 amp-hours. In applications where sustained high current draw may be expected this factor must be taken into account when sizing the battery system.

## F) Battery (DC) Wiring

**CAUTION:** Assure that hydrogen gas does not accumulate near the battery by keeping the area well ventilated. A substantial spark may result when connecting the final battery wiring due to an initial



charging of the internal input capacitor.

FIGURE 2 illustrates a typical battery wiring configuration (along with temperature sensor wiring, discussed in section G, following):

**FIGURE 2: Typical Battery Wiring**

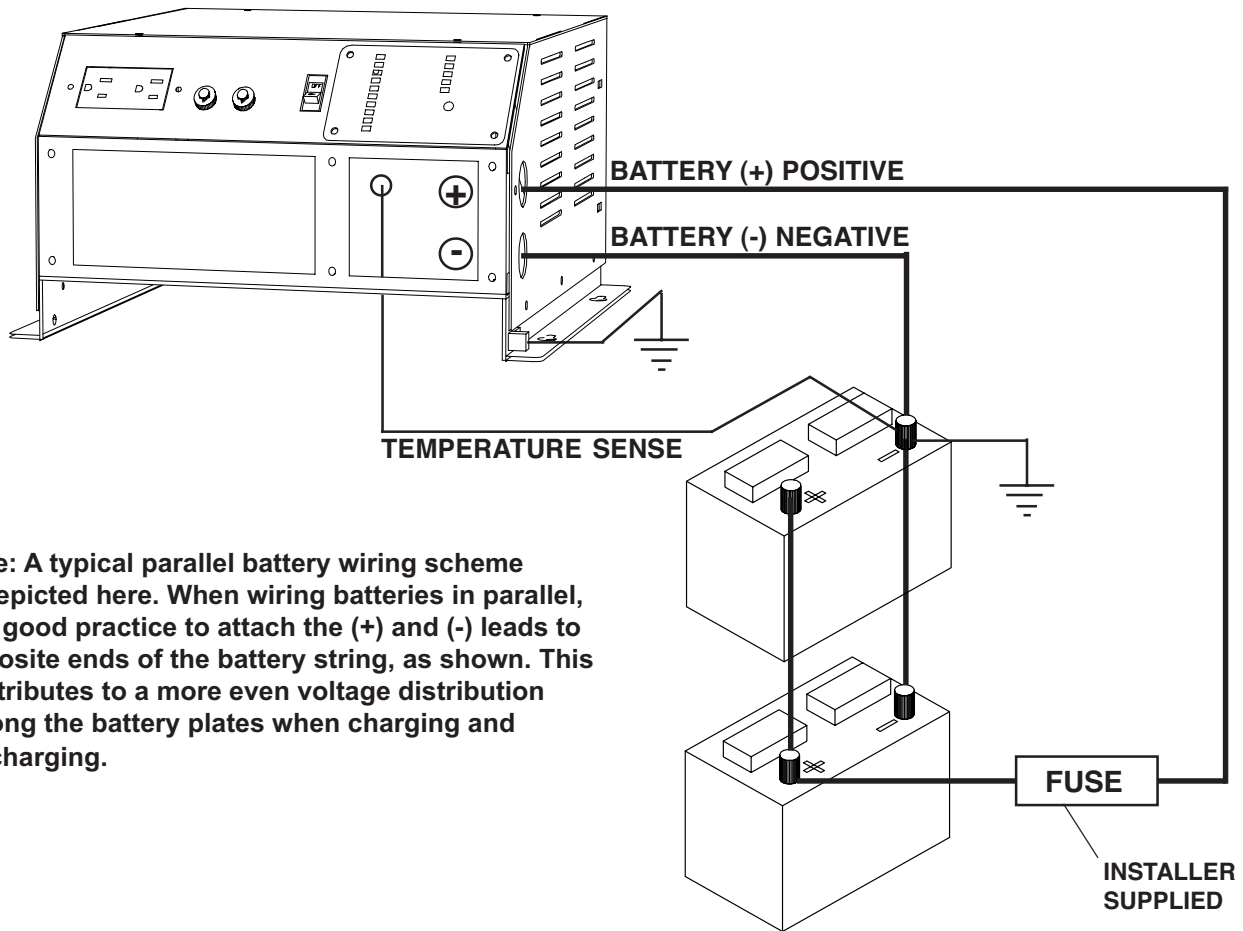

**Note:** A typical parallel battery wiring scheme is depicted here. When wiring batteries in parallel, it is good practice to attach the (+) and (-) leads to opposite ends of the battery string, as shown. This contributes to a more even voltage distribution among the battery plates when charging and discharging.

Use the following procedure to calculate the required amp-hour capacity for your battery system:

*Note: It is assumed that the batteries are a suitable deep-cycle type, that discharge will not exceed 50%, and that batteries will be fully recharged after each cycle of inverter use.*

- 1) Determine the maximum amount of time in hours that the inverter will run the loads before an external source of AC becomes available and batteries can be fully recharged.
- 2) Survey all AC appliances and determine how many watt-hours will be consumed by each during that same period. For instance, if a 100 watt TV will be powered for 3 hours, that equals 300 watt-hours. If a 1,500 watt microwave will also be run for half an hour, then that is another 750 watt-hours (i.e.,  $1,500 \times .5$ ). Bear in mind that some loads, such as refrigerators, are intermittent, so an average must be used.

### Wire Size Chart

Model	Length of Wire from Charger to Batteries (in feet)			
	10'	15'	20'	Over 20'
	Minimum Wire Gauge (AWG)			
12-3000IC (& DV)	2/0	2/0	2/0	Not Recommended
24-4800IC (& DV)	2/0	2/0	2/0	Not Recommended

*\*Meets minimum requirements of ABYC 10% voltage drop table for inverter maximum input current, 3% voltage drop table for charger maximum output, and allowable amperage for 105° C rated insulation conductors <50 VDC inside engine space. Consult ABYC E-9 for lower temperature rated insulated conductors.*

**CAUTION:** Ensure that leads are properly fused at the battery. (Refer to ABYC recommendations regarding fuse type and location.)

Model	Fuse Value
12-3000IC (& DV)	400
24-4800IC (& DV)	300

To gain access to the DC wiring lugs of the inverter/charger, remove the wiring access cover from the front of the unit (plate is screened with the “Perfect Wave” trademark/logo), which is held in place by six phillips-head screws.

A pair of large screw compression lugs for DC wiring are located in the compartment on the far right. Use the provided 3/8" hex wrench for loosening and tightening these terminals.

**CAUTION:** Do not attempt to loosen or tighten these terminals when the DC wiring is connected to a battery. There is a possibility of shorting through the wrench between the case and the (+) terminal, which will cause a violent spark and possible injury.

**CAUTION:** Do not loosen the hex head bolts which secure the terminals to the interior of the unit. Use *only* the allen set screws for securing the battery cable.

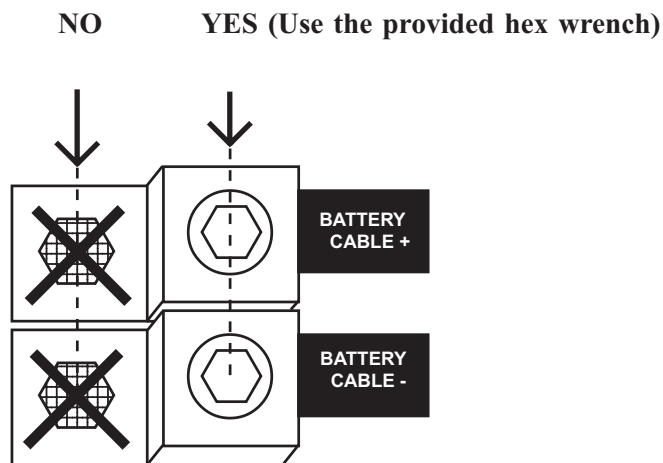



DC wires are fed through the two access ports on the right-hand side of the unit labeled “(+) POSITIVE” and “(-) NEGATIVE”. After the wires have been attached to the terminals, tighten the cable strain relief securely with a phillips screwdriver to protect against any possible loosening of the DC wires.

Install a properly sized and located DC fuse (as per ABYC recommendations cited above) in the positive leg of the battery wiring, then attach the wires to the battery, carefully observing correct polarity.

*Note: It is normal to encounter a spark when connecting the final battery wiring due to the initial charging of an internal input capacitor.*

*Note:* The temperature compensation sensor will also be attached to the negative terminal of the battery, so complete that installation also (as described in the section F, following) before securing the negative terminal lug.

*CAUTION:* A reverse polarity connection will result in damage to the inverter/charger which is not covered under the warranty.

### **G) Charging Multiple Battery Banks**

If desired, the charger may be wired to charge multiple battery banks. This can be accomplished using NEWMAR’s BI-100 (12 volt) or BI-24-100 (24 volt) Battery Integrator. The device acts as a “smart” switch, connecting independent battery banks only when a charging voltage is present, then disconnecting them for selective discharge. This allows you to also charge an engine start bank, for instance, whenever external AC is present, but draw current only from the house or dedicated inverter bank whenever the inverter is operating.

*Note:* Standard diode-type isolators are not recommended for splitting the output of the internal charger among multiple battery banks, as the voltage drop through the diodes will result in chronic undercharging of the additional banks.

A separate Battery Integrator is required for each additional battery bank to be charged. Contact the factory for more information.

### **H) Temperature Compensation Sensor**

The nominal output voltages for the charger (which are discussed later in this manual) are ideal for a battery at about 72° F. However, the ideal charging voltage will vary according to temperature. Higher battery temperature requires a lower charging voltage and vice versa. Therefore, the inverter/charger is equipped with a temperature sensor which automatically raises and lowers output voltage according to the temperature sensed on the battery post.

A 20 foot sensor cable has been factory-installed and is routed through the access port at the bottom of the compartment (along with the remote panel in-line plug assembly).

The sensor must be securely attached to the *negative* post of the battery. A 3/8" ring terminal on the end is provided for this purpose.

*CAUTION:* Failure to install the temperature sensor properly may result in overcharging or undercharging of the batteries. Extreme overcharge may cause severe damage or exploding batteries and fire.



**ELECTRONIC POWER PRODUCTS**  
**COMMUNICATION • NAVIGATION**

[www.newmarpower.com](http://www.newmarpower.com)

## I) AC Input Wiring

The inverter/charger is designed for hardwire AC input only. The AC input serves two functions:

- 1) One set of input wires provides power for the internal battery charger whenever external AC is available.
- 2) A second set of input wires allows routing of an external AC source through the inverter/charger so that, by use of a built-in automatic transfer switch, AC is available directly from the unit at all times either from the inverter or shore/generator power. These wires feed both the duplex outlets and AC hardwire output. **Caution: The input wires for the transfer switch must have power for the battery charger to operate. Turning the charger circuit on with out the transfer circuit being energized will damage the unit.**

AC input wires are located in the left-hand compartment on the unit front. *Do not* confuse the AC input wires and the AC output wires, also located in the same compartment. (Refer to Figure 3 on the following page for input and output wiring locations.) *Applying AC from an external source to the AC output wires will cause severe damage and void the warranty.*

*AC input wiring for the inverter transfer switch must be routed through a 50 amp (or less) fuse or circuit breaker on an AC distribution panel with proper safety/earth chassis ground in accordance with all applicable local codes and ordinances. AC input to the charger wiring should be routed through a 20 amp fuse or circuit breaker on 220 volt units ("DV" models) and through a 30 amp fuse or circuit breaker on 120 volt units.*

If you are using two separate hot legs, the input wires for the transfer switch and battery charger must be in the same phase (i.e., use the same neutral). If you are using one hot 115V leg, then the same hot (H), neutral (N) and ground (G) can feed both inputs.

Battery Charger AC input wires are 12 AWG. Transfer relay input wires are 8 AWG.  
All AC input and output wires are color-coded as follows:

**Black.....Hot (H)**  
**White.....Neutral (N)**  
**Green.....Ground (safety, earth or G)**

Use identically sized and color coded wiring for AC input to the inverter/charger, as well. Feed the wires through the bottom access port/strain relief into the AC wiring compartment. The internal wires have been factory-fitted with appropriately sized butt splices. Use a crimping tool to connect the wires, then tighten the strain relief securely.

*A Note about Parallel Wiring:* If the installation requires, both AC inputs may be fed by a single source, however the installer must be aware of the following: The maximum current which may be passed through the transfer relay is 50 amps. At full output the battery charger may draw as much as 30 amps\*. Therefore, when wired this way it is possible for the entire current draw to exceed the maximum of 50 amps shorepower and trip the shore cord circuit breaker.

\* See input and specs on page 20.

**FIGURE 3: AC Input and Output Wiring**

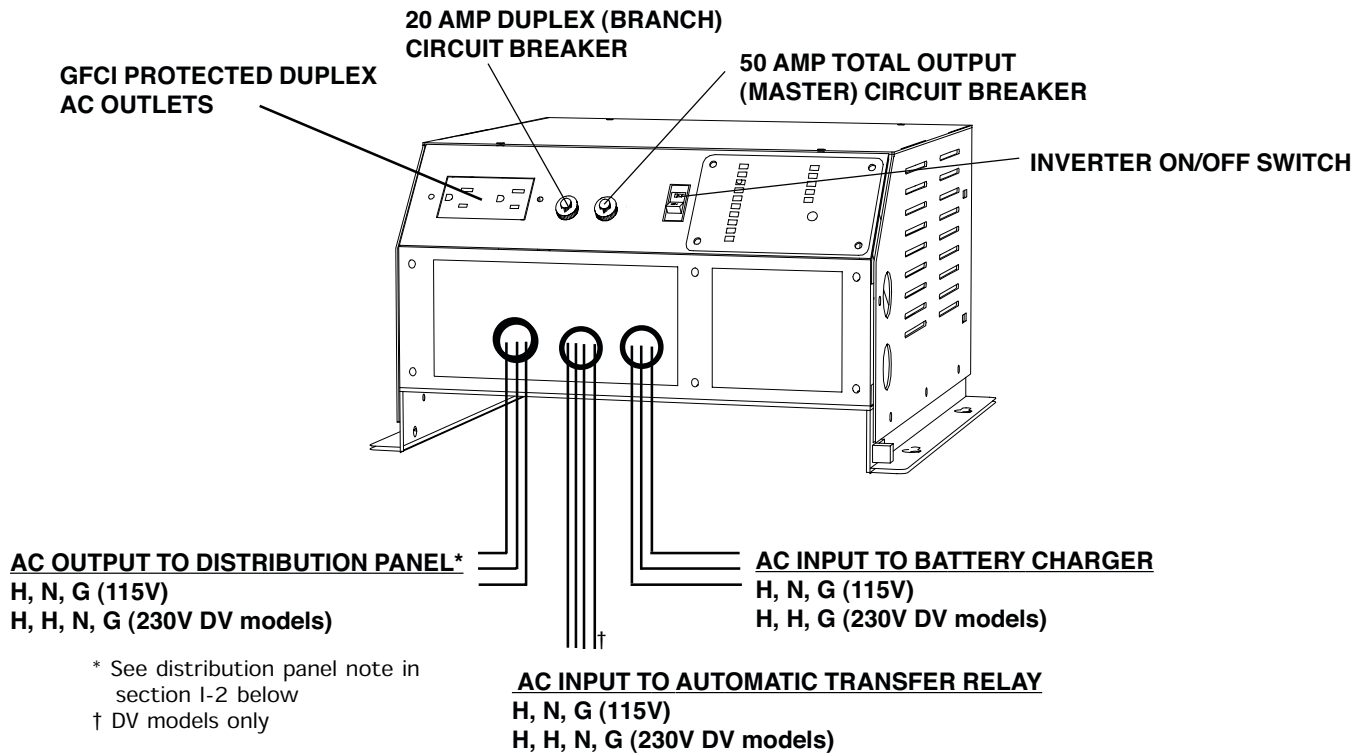

## J) AC Output Options

AC output is available from both the front panel AC duplex outlets or via the AC hard-wired output, which is typically routed through an AC distribution panel.

**1) AC Outlets:** Two outlets are provided for USA standard three-prong plugs. The maximum current draw through both outlets combined at any one time is 20 amps. The outlets are over-current protected by a resettable 20 amp “Branch” output breaker on the front panel beside the outlets.

The outlets are protected by a GFCI (Ground Fault Circuit Interrupter) which automatically disconnects the outlets when any significant amount of AC is detected on the ground circuit which could present a shock hazard. *Note:* The AC hard-wire output is not GFCI protected.

### 2) AC Output Hard-Wiring

*CAUTION:* Integrating the inverter output with existing AC branch circuits must only be attempted by a qualified marine electrician. Options may include isolating breakers on an existing panel or installing a separate, dedicated inverter AC sub-panel. The three AC output wires are located in the AC wiring compartment to the left of the input wires. Wire gauge, color-coding, routing and connection are the same as recommended for AC hard-wire input in the previous section.

*CAUTION:* Do not connect any other source of AC power directly to the output of the inverter. This will result in damage not covered under the warranty.



50 amps is the maximum AC current output of the *entire* inverter including AC hard-wire output and both outlets. (This does not include the current supplied to the battery charger if the AC source is external). The inverter's internal wiring is over-current protected by a resettable 50 amp "Output" breaker located beside the "Branch" output breaker on the front panel.

**IMPORTANT INSTALLATION NOTE:** Per ABYC section A-25 a label must be installed at the main electrical panel to warn anyone who may work on that panel that an inverter has been installed. This is because it might be falsely assumed that after the AC main has been shut off the panel is no longer "hot", when it may still be, due to the automatic functioning of the inverter. A set of AC distribution panel warning labels has been provided in the installation kit. Choose the preferred black or white background label and affix it in a clearly visible location at the panel.

**CAUTION:** The AC outlets and AC hard-wire outputs on the inverter remain "live" when derived from an external source, even when the inverter is shut off.

### K) Remote Panel (Optional)

Remote monitoring of inverter/charger functions, as well as inverter output activation/shut-off, may be obtained using model ICR-2 Remote Panel, available from NEWMAR. The panel duplicates all of the LED status indicators (discussed in sections IV and V following) which are on the front panel and incorporates a secondary on-off switch for the inverter.

**FIGURE 4: Remote Panel Installation**

**PANEL DIMENSIONS: 4 1/2" HIGH x 4 1/2" WIDE**

**PANEL REAR CUT-OUT AREA  
(for bulkhead mount): 2 7/8" HIGH x 3 3/4" WIDE**

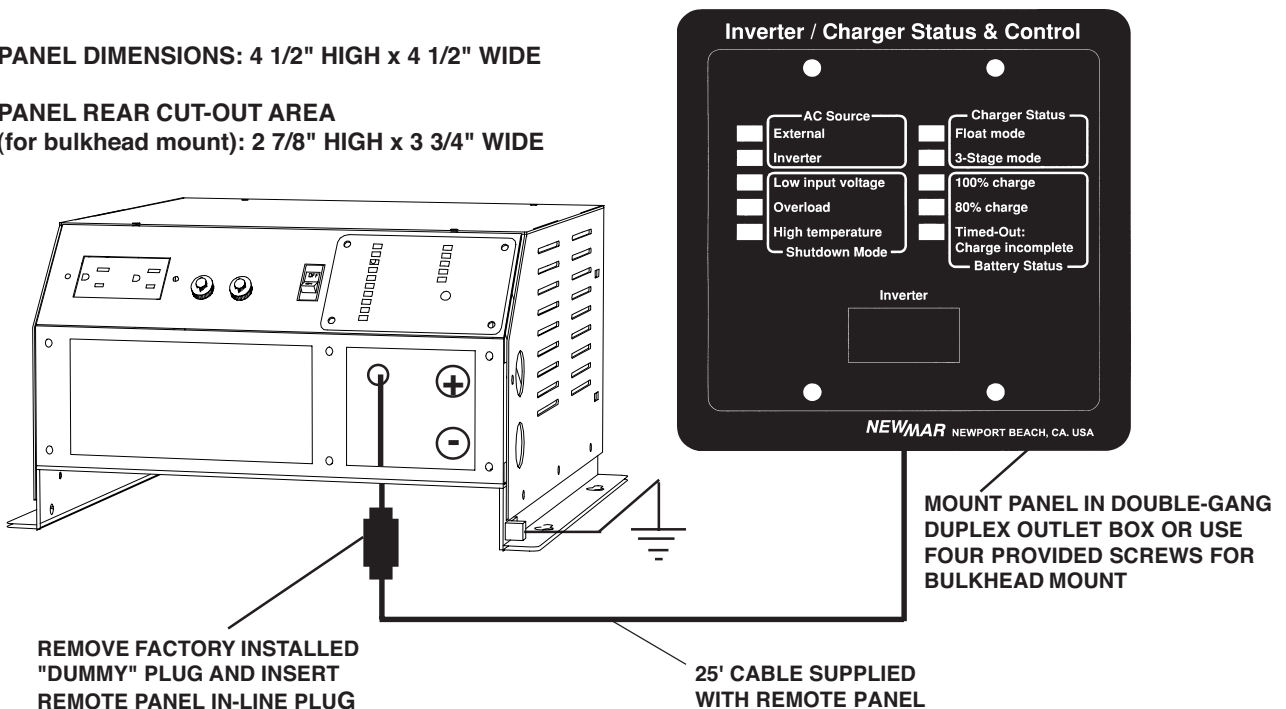

The panel face and mounting hole pattern have been designed for an exact fit within a double-gang duplex outlet box. If preferred, it may be mounted directly to a bulkhead with the four provided black-

oxide wood screws. Note the cut-out dimensions specified in Figure 4 and take special care when making the cut-out, as the tolerances between the mounting holes and rear-mounted circuit board are quite small.

The ICR-2 is supplied with 25 feet of cable. If additional length is required, contact the factory for an extension cable.

The inverter/charger is equipped with a factory-installed in-line connector assembly for the remote panel. The connector has a “dummy” plug attached which enables all of the inverter/charger functions when no remote panel is used. Remove and *save* this plug prior to attaching the remote panel plug. (The dummy plug is required to restore proper functioning of the unit if the remote panel must be disconnected for any reason in the future.)

The connector assembly is keyed to ensure correct orientation and uses a threaded collar to secure the connection. Upon inserting the plug, tighten the collar until a “click” is felt, indicating it has locked together properly.

*Note:* In order for the remote on-off switch to operate, the on-off switch on the inverter front must be in the “ON” position.

#### **IV) BATTERY CHARGER OPERATION**

Battery capacity and battery type selections *must* be set prior to applying AC to the charger.

##### **A) Battery Capacity Selector**

Part of the internal charger’s “smart” charging algorithm involves calculating and delivering the proper charge current in the latter stages partially based on the total amp-hour capacity of the battery bank. This information is provided to the charger using a recessed selector switch located on the right-hand side of the unit, near the rear. (Do not confuse this selector with the Charger Output Selector located beside it—see section B, following).

Determine the total amp-hour capacity of the battery system which is being charged by the inverter/charger. (If multiple banks are being charged, include all banks, not just the bank which powers the inverter.) Then use a small flat-tip screwdriver to place the selector into the correct position according to the following chart (this information is also duplicated on the unit beside the selector port):

##### **Battery Capacity Selection Chart**

<u>Switch Position</u>	<u>Total Battery Capacity (in Amp-Hours)</u>
A	600 or more
B	400-599
C	200-399
D	199 or less



**ELECTRONIC POWER PRODUCTS**  
**COMMUNICATION • NAVIGATION**

[www.newmarpower.com](http://www.newmarpower.com)

## B) Charger Output Selector

The ideal charge regimen for gel-cell and flooded (wet) lead-acid or AGM (Absorbed Glass Mat) batteries differs somewhat. Gelled electrolyte may be lost or damaged by high voltage and, once lost, cannot be replaced as it can with a wet lead acid battery. (The charge regimen recommended for AGM batteries is typically similar to that of flooded lead-acid batteries.) Consequently, the charger is equipped with a switch for selecting the proper charge voltage, based on battery type.

The Charger Output Selector is a recessed selector switch also located on the right-hand side of the unit, near the rear, beside the Battery Capacity selector. There are four positions on this selector; *only* positions C or D (depending on battery type) are used for normal charger operation. (The A and B positions are used for a special equalization output, which is discussed shortly.)

Verify the type of batteries being used, then use a small flat-tip screwdriver to place the selector into the correct position according to the chart below (this information is also duplicated on the unit beside the selector port). *Note:* Mixing of battery types such as gel-cell and flooded on the output of the charger is *not* recommended, even if output is split among multiple banks with an isolator or integrator:

### Charger Output Selection Chart: 12-3000IC (& DV)

Switch Position	Use For	Output Voltage (VDC)	
		@ Charge	@ Float
A	Equalization <i>CAUTION</i>	15.2	13.2
B	Equalization <i>CAUTION</i>	14.6	13.2
C	Flooded/AGM Charging	14.2	13.2
D	Gel-Cell Charging	13.8	13.2

### Charger Output Selection Chart: 24-4800IC (& DV)

Switch Position	Use For	Output Voltage (VDC)	
		@ Charge	@ Float
A	Equalization <i>CAUTION</i>	30.4	26.4
B	Equalization <i>CAUTION</i>	29.2	26.4
C	Flooded/AGM Charging	28.4	26.4
D	Gel-Cell Charging	27.6	26.4

### Some notes and warnings regarding the equalization circuit:

*WARNING: Equalization of batteries should only be done with a clear understanding of the process and is performed entirely at the user's risk. Some battery types will be damaged by equalization. Refer to the battery manufacturer for recommendations regarding equalization.*

Some manufacturers of flooded lead-acid batteries recommend a charging process known as equalization for extended battery life. This is because the normal charging/discharging process will, over time, leave a deposit of sulfate on the battery plates which degrades overall performance and is exacerbated by uneven voltage potential between the plates. The equalization process involves occasionally charging a wet lead-acid battery at a very high voltage for a short period of time in order to completely desulfate the battery plates, and "equalize" the voltage between them.

*CAUTION:* Equalization is *not* recommended for sealed valve regulated or gel-cell batteries.

- Equalization should only be performed with no load on the battery system so that effective equalization voltage is maintained throughout the cycle. In addition, some loads may be harmed by the higher voltages required by equalization.
- Upon applying AC to the charger, the equalization circuit will typically be engaged for about four hours, after which it will revert to the 13.2 or 26.4 VDC enable mode (discussed later). If longer equalization time is desired, turn the charger off for about five seconds then turn it back on to start another four hour cycle.
- As long as the switch is left in either of the equalization settings (A or B) it will return to that high output voltage as part of the charge cycle *every time the charger is turned off and back on*. Be sure to return the Charger Output Selector to the normal “C” output setting immediately after equalization is finished. Otherwise damage to the batteries and to DC equipment being powered by the batteries may result.

### C) Battery Charging Cycle and Status L.E.D.'s Explained

The internal charger utilizes the three stage charge regimen which is widely recommended by battery manufacturers for allowing the fastest possible recharge time without exceeding the batteries' gas point limit.

This three stage regimen is initiated each time AC is first applied, when drained batteries are most likely to be encountered, then proceeds through each stage at a rate which is dictated by the battery's relative state of charge (or the internally set time limits) throughout the cycle.

*Note:* When external AC is applied first applied to the unit, it takes approximately 30 seconds for the unit to run various self-checking functions before the automatic transfer relay is engaged. At that point the “AC Source: External” and “Charger Status: 3-Stage Mode” L.E.D.'s will illuminate. If the inverter happens to be operating when external AC is applied, it will continue to operate throughout this 30 second transition period.

The typical three stage charge regimen with no DC load on the batteries proceeds as follows (refer also to flow chart on page16):

**1) Bulk Stage:** When the AC to the charger is first cycled on and significantly discharged batteries are sensed, the charger responds by delivering a high amount of DC current, at or near the charger's maximum rated output, in order to rapidly replenish them. It is during this stage that charging current is maintained at a high level as battery voltage is driven to the “Charge” voltage limit designated by the Charger Output Selector. Bulk charging continues until the batteries are at about 80% of capacity, as verified by a sophisticated battery “gas point detection” circuit. At that point the charger switches to the absorption stage and the “80 % Charge” L.E.D. on the front panel (and remote panel, if used) will illuminate.



**ELECTRONIC POWER PRODUCTS**  
**COMMUNICATION • NAVIGATION**

[www.newmarpower.com](http://www.newmarpower.com)

15

P.O. Box 1306  
Newport Beach,  
California 92663

Phone: 714-751-0488  
Fax: 714-957-1621  
E-Mail: [sales@newmarpower.com](mailto:sales@newmarpower.com)

**FIGURE 5: Charger Operation and L.E.D. Indication Flow Chart**

**Status Panel Indications**

■ = L.E.D. Illuminated  
 □ = L.E.D. Not Illuminated

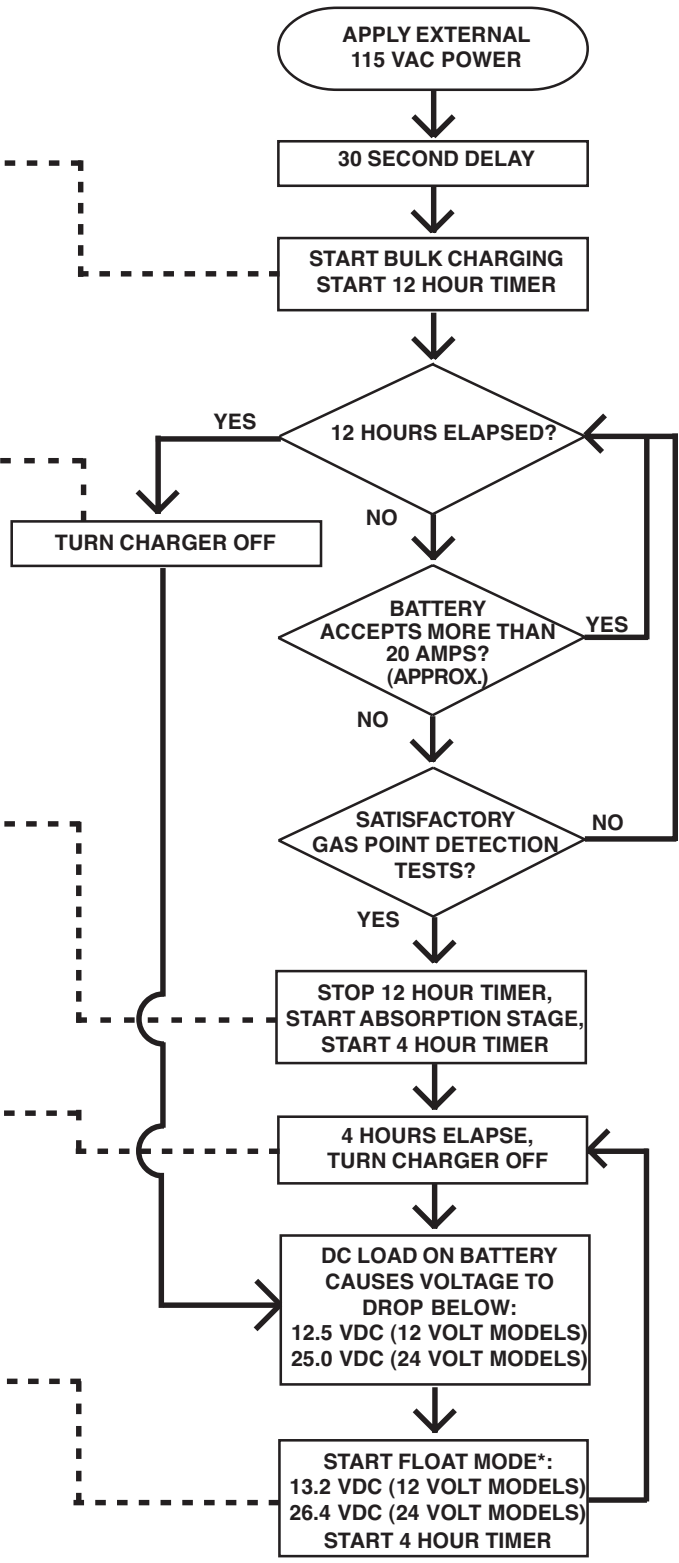
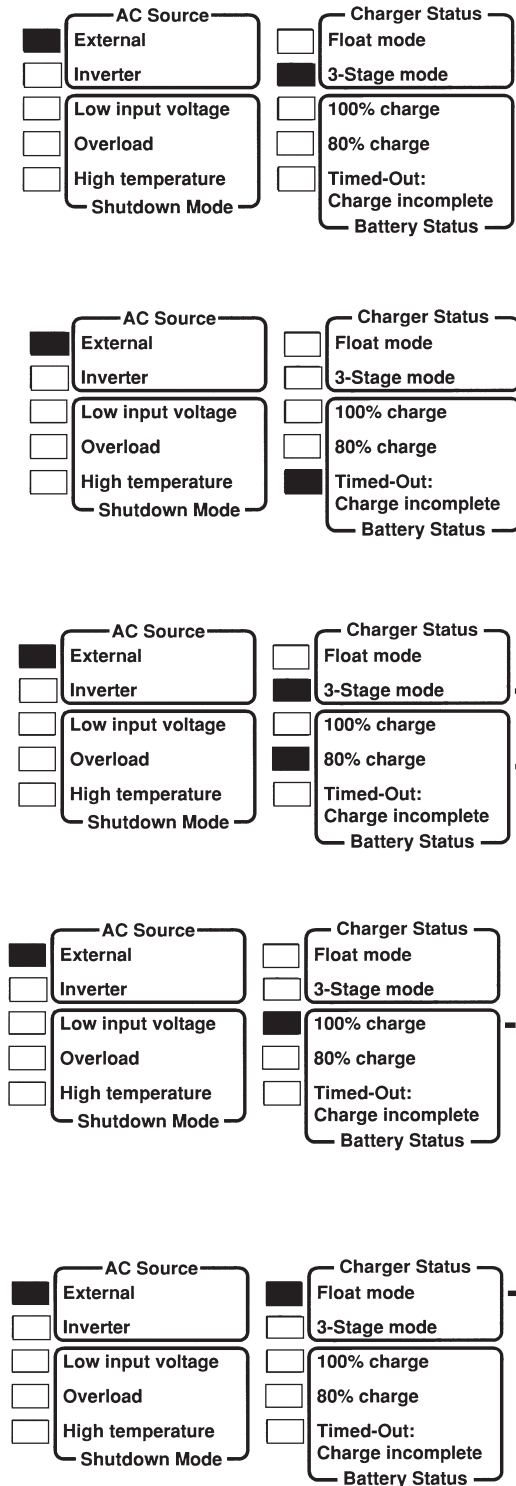

\* Note: Three stage charge cycle resumes (goes to top of chart) each time external AC is removed then reapplied.



**2) Absorption Stage:** During this second stage of the charge cycle, battery voltage is maintained at the “Charge” voltage level, while output current is delivered to saturate the battery plates. This takes place at a rate of about 5 % of battery capacity per hour for four hours. At the end of this four hour period the batteries are fully charged; the “100 % Charge” L.E.D. will illuminate and the charger output will switch off entirely.

**3) Float Stage:** In order to prevent battery damage by extended periods of DC current draw which would normally demand higher voltage as in the first two stages, the charger automatically reverts to a “Float” mode. In this mode the charger is shut off and remains dormant until any draw on the batteries causes them to fall below 12.5 VDC (12 volt models) or 25.0 VDC (24 volt model). At this point the charger will switch on and begin to output a float voltage of 13.2 VDC (or 26.4 VDC) at an amperage which is enough to supply the DC loads. At the same time the “Float Mode” L.E.D. will illuminate. (*Note:* While in the Float stage, the charger is still able to deliver its full rated current output, as load demands.) At the same time a four hour cycle is initiated. If, at the end of four hours, the batteries remain above 12.5 VDC (or 25.0 VDC), the charger will shut off and remain off until DC loads again cause batteries to drop below that point, and the four hour timed float cycle repeats.

The preceding paragraphs briefly describe the charger functions during normal or optimal charging conditions. However, certain conditions, such as a high load on the batteries during the charge cycle or a momentary interruption of external AC power during the charge cycle may cause somewhat different operation, such as charging time-out or charge timer reset. The Charger Output Flow Chart (FIGURE 5) on page 16 outlines the charging process step-by-step and illustrates the charger’s response to various influencing factors.

**A note regarding the “Timed-out: Charge Incomplete” L.E.D.**

To protect batteries from damaging overcharge due to extended exposure to high “Charge” voltage, a timer is initiated each time the charger is turned on, which shuts the charger off if fully charged batteries are not sensed within a 12 hour period. When this occurs the “Timed-out: Charge Incomplete” L.E.D. will illuminate. It will remain illuminated until **a)** the 12 hour charge cycle is restarted by turning the AC input off, then on again, or **b)** the battery voltage falls to 12.5 VDC (12-3000IC) or 25.0 VDC (24-4800IC), in which case it will switch to the “Float” mode (described above).

*Note:* This is not necessarily a failure condition; it may merely be the result of some transitory and non-recurring condition during the charge cycle. However, if the charger repeatedly times out before full charge is achieved, the cause should be investigated and remedied.

These are some of the conditions which may cause the charger to time out before batteries are 100 % charged:

- 1) There is a high wattage draw on the inverter output which reduces power available to the charger (condition described in previous section).
- 2) The actual battery amp-hour capacity is higher than was designated using the Battery Capacity Selector switch.
- 3) A DC load greater than 20 amps is drawn from the batteries during the initial 12 hour cycle.



4) The charger is unable to detect the 80 % charge level due to a shorted cell, incorrect acid density or some other battery defect.

## **V) INVERTER OPERATION**

### **A) Start-Up/Operation**

When all battery and AC wiring has been correctly installed, check for proper operation as follows:

1) With no external AC applied, turn the power switch on the front of the unit to “On”. The “Inverter” L.E.D. should illuminate.

*Note:* If the remote panel is used, the power switch on that panel must also be turned on for the inverter to operate. In addition, every L.E.D. indication on the remote panel should be identical to the indication on the front panel of the inverter. Verify that this is so during start-up tests and initial operation.

2) Plug an AC appliance into each of the two receptacles (outlets) on the front of the inverter and verify proper operation. If the appliance does not operate, the black GFCI test button may have been inadvertently pushed during installation. Press the red reset button and the appliance should then operate.

3) Check the proper hard-wire output (if used) by plugging the appliance into a receptacle which is fed by the AC distribution system.

4) Apply external (shorepower or generator) AC to the hard-wired input of the inverter. *After a delay of approximately 30 seconds* the internal automatic transfer switch should activate and the “AC Source: External” and “Battery Charger” L.E.D.’s should illuminate.

5) Remove the external AC source. The automatic transfer switch should activate immediately, and the “AC Source: Inverter” L.E.D. should again illuminate.

Having completed this initial test the external AC source may be reapplied and all inverter/charger functions should then be operational with no further attention required, other than occasional status checks, as desired. You may wish to monitor progress of the charger L.E.D.’s the first time through the charging process (as described in the previous chapter) to verify proper operation of that circuit, as well.

### **B) Inverter ON/OFF Switch Functions**

It is important understand the functioning of the ON/OFF switch of the inverter, so that there can be no incorrect assumption about when AC is being applied within the unit, at the duplex outlets or the AC hard-wire output.

1) The ON/OFF switch (either on the front or remote panel) controls *only* whether the internal DC-AC inverter is operating. *Whenever external AC is applied* the internal battery charger is operational and AC is being applied to both the duplex outlets and



the AC hard-wire output. Only shutting off the external AC at its source will prevent AC flow through the inverter. (Note that, when external AC is available the "External" L.E.D. remains illuminated, regardless of which position the ON/OFF switch is in.)

2) If a remote panel is connected and:

**a)** the front panel switch is ON, then the inverter can be controlled with the remote ON/OFF switch.

**b)** the front panel switch is OFF, then the inverter remains off, regardless of the position of the switch on the remote panel.

### C) Inverter Auto-Shutdown Indications and Causes

Three "Shutdown Mode" L.E.D.s are provided to indicate an abnormal condition which has caused the inverter to cease functioning temporarily. The indicators and likely causes are as follows:

1) **"Low Input Voltage"** L.E.D.: Batteries may be permanently damaged by extreme discharge. Therefore, the inverter monitors battery voltage and shuts off when it reaches a critical low point (10.5 or 21.0 VDC). Typically, this occurs when operating the inverter for long periods without any external AC source coming on line to recharge the batteries. If this condition occurs soon after the inverter is turned on, it may be due to an undersized, old/weak battery system or to under-sized/over-length battery wiring. Verify proper battery capacity and health then recharge fully.

2) **"Overload"** L.E.D.: This may be due to either of two causes; short circuit or too much wattage demand. Remove all AC loads. If the indicator remains lit, then a short circuit is likely. Check AC output wiring carefully. If load removal causes this L.E.D. to be extinguished then the demand is probably exceeding the inverter's rating. Check the total wattage of all appliances being used at one time and this is within the unit's rating.

3) **"High Temperature"** L.E.D.: The inverter employs one or two integral cooling fans depending on model which operate automatically to keep the unit within rated operating temperature—under normal operation, and when properly installed. It is also protected, however, by an internal thermal switch which shuts the unit completely off when it gets too hot. This is typically due to being located in a high temperature area or a small enclosure which restricts air flow, or due to a blockage of the air intake of the cooling fans. Ensure free flow of air around and into the unit. Relocate it if necessary. *Note:* The thermal switch is self-resetting, so the inverter/charger will automatically return to service when it cools to a safe operating temperature. Nevertheless, thermal cycling of this sort will shorten the life of the unit, and should not be allowed to continue if it is noted.

## VI) SPECIFICATIONS

<b>MODEL:</b>	<b>12-3000IC</b>	<b>12-3000IC-DV</b>	<b>24-4800IC</b>	<b>24-4800IC-DV</b>
<b><u>Inverter Output:</u></b>				
VAC	115V, 60Hz	115/230V, 60 Hz	115V, 60 Hz	115/230V, 60 Hz
Watts (Surge)	6,500	6,500	14,000	14,000
Watts (Cont.)	3,000	3,000	4,800	4,800
Wave Type	Pure Sine	Pure Sine	Pure Sine	Pure Sine
<b><u>Inverter Input:</u></b>				
VDC	11-14	11-14	22-28	22-28
Max Amps	300	300	240	240
Typical Battery Capacity (A-H)	900-3,000	900-3000	720-2,400	720-2,400
<b><u>Charger Output:</u></b>				
VDC (@ Float)	13.2	13.2	26.4	26.4
Max Amps*	105	105	100	105
<b><u>Charger Input:</u></b>				
VAC	115V, 60 Hz	230V, 60 Hz	115V, 60 Hz	230V, 60 Hz
Max Amps	20	10	30	15
<b>Weight (Lbs.):</b>	75	80	95	100

\*@120VAC or 240VAC. Reduced charge output @ lower input voltages

<b><u>Case Size (Inches, All Models):</u></b>	<b>Height</b>	<b>Width</b>	<b>Depth</b>
	10"	17"	16"

**Internal Charger Type:** Three stage "smart charger", programmable;  
Output voltage depends on program selected for gel, flooded lead-acid,  
or AGM battery type

### **Charger Output Voltages (as determined by Charger Output Selector)**

#### **12 Volt Models**

Switch Position	Use For	Output Voltage (VDC)	
		@ Charge	@ Float
A	Equalization <i>CAUTION</i>	15.2	13.2
B	Equalization <i>CAUTION</i>	14.6	13.2
C	Flooded/AGM Charging	14.2	13.2
D	Gel-Cell Charging	13.8	13.2

#### **24 Volt Models**

Switch Position	Use For	Output Voltage (VDC)	
		@ Charge	@ Float
A	Equalization <i>CAUTION</i>	30.4	26.4
B	Equalization <i>CAUTION</i>	29.2	26.4
C	Flooded/AGM Charging	28.4	26.4
D	Gel-Cell Charging	27.6	26.4



**Operating Temperature:** -22° C to +40° C (0° F to 104°F)

**Mechanical Features:**

- Thermally controlled cooling fans
- GFCI protected duplex outlets
- Powder coated aluminum case with integral mounting flanges
- Conformal coated printed circuit boards

**Protection Features:**

- Automatic low battery shutdown
- Output circuit breakers
- Auto high temperature shutdown/recovery
- Short circuit protection
- Overload protection

**Compliance:**

- UL 458 Listed

**Options**

- Remote control and indicator panel; provided with 25' of cable. Model: ICR-2
- Battery Integrator for charging multiple output banks. Model: BI-100 (12 volt) or BI-24-100 (24 volt)
- Digital DC Energy monitor for precise indication of battery volts, amps, amp-hours used and remaining. Includes programmable high/low voltage remote alarms. Model: DCE
- Blank Panel which accommodates both ICR-2 remote panel and NEWMAR digital instrument or 2 1/2" panel meter. Model: MPB-IC2



**ELECTRONIC POWER PRODUCTS**  
COMMUNICATION • NAVIGATION

[www.newmarpower.com](http://www.newmarpower.com)

## **VII) BATTERY CARE TIPS**

Regular maintenance and proper care will assure you reliable service from the most depended upon and sometimes most neglected items, your batteries and battery charger. NEWMAR battery chargers are designed to keep your batteries fully charged but your batteries also need proper regular maintenance to provide a maximum life of service.

### ***ALWAYS READ AND FOLLOW THE BATTERY MANUFACTURER'S INSTRUCTIONS***

#### **Battery Installation**

Batteries must be securely mounted to prevent them from falling over when the vehicle or boat is in motion. A loose battery can do serious damage. Batteries should be mounted in a battery box to contain any acid spill. Batteries give off a certain amount of hydrogen gas when they are charging. When concentrated, this gas is highly explosive. Therefore make sure they are in an accessible place with adequate ventilation for any hydrogen gas discharge.

#### **Cleaning Batteries**

Dirt and electrolyte salts can build up on the top of your batteries. This accumulation conducts electricity stored in the battery and can cause the battery to discharge by itself. Therefore, at least twice a year, it is a good idea to disconnect the battery cables and scrub the battery with a baking soda solution. Rinse with fresh water and dry with a clean cloth.

You may wish to purchase a set of terminal post corrosion prevention rings. These are alkali-saturated felt rings that slip over the battery post to reduce corrosion. Do not apply grease to any part of the battery terminals, but you may use an occasional light spray of silicone lubricant.

#### **Routine Checks and Maintenance**

Batteries should periodically be "exercised" (slowly discharged and then recharged) to keep them in top condition. New batteries may need to be exercised before they will be capable of their full rating.

If your batteries are not the sealed type, distilled water should be added to them whenever needed. The electrolyte should cover the plates by about 1/2", allowing a small air space at the top. Do not fill the cells up to the filler cap as this could cause the battery to sputter out electrolyte when it is being charged. Only distilled water should be used never plain tap water. Tap water contains chemicals and elements that can alter the properties of the electrolyte, including specific gravity. Some chemicals may also create an insulating coating on the battery plates which will retard current flow.

The rate that water is lost by the battery is dependent on several factors; battery condition, ambient temperature, battery use, charge voltage, etc. It is normal for batteries which are not maintenance-free to require topping off about once a month.

A battery's state of charge may be monitored by checking the specific gravity or by open circuit



voltage. You may use the following table to evaluate the condition of your batteries:

### Battery Condition Table

#### Specific Gravity

#### Measured by

#### Hydrometer

#### Open Circuit Voltage

#### State of

#### Discharge @ 80° F

1.265	12.6 or more	Fully Charged
1.225	12.4	25 % Discharged
1.190	12.2	50 % Discharged
1.155	12.0	75 % Discharged
1.120	11.7 or less	100 % Discharged

*\* Note: Wait at least 5 minutes after charging or discharging before checking specific gravity or open circuit voltage. The battery's voltage needs to stabilize in order to get an accurate reading.*

### Troubleshooting Your Battery System

If your battery will not accept or hold a charge, one of the following conditions may exist:

1. **A BAD BATTERY.** You may have a battery with an open or shorted cell, a battery without any "life" left. Check by charging the battery until all cells have a specific gravity of 1.225 or greater at 80° F. If you are unable to obtain 1.225 in each cell, replace the battery.

2. **A BAD BATTERY CHARGER.** If the battery open circuit voltage is low and/or the hydrometer indicates your batteries are low, the battery charger should be providing current to the batteries. If it is not, check the input fuse and check to see that you have charging voltage on the output with no battery attached. *Note: You will not get an accurate voltage reading on the output of the charger with no batteries attached. This is checked merely to ensure that you do not have an open circuit on the output.*

The battery charger has a thermal power reduction circuit to protect the charger from overheating. If you suspect this is the case, refer to the INSTALLATION section for information about proper charger location.

3. **ELECTRICAL LEAKAGE.** You may have a previously unsuspected source of current drain from the battery. To check for a leakage of this sort, disconnect the battery ground cable and connect an ammeter between the negative battery post and ground. If you have a reading over .1 amp, there is a source of current drain from the batteries which must be located and removed.



**ELECTRONIC POWER PRODUCTS**  
**COMMUNICATION • NAVIGATION**

[www.newmarpower.com](http://www.newmarpower.com)

23

P.O. Box 1306  
Newport Beach,  
California 92663

Phone: 714-751-0488

Fax: 714-957-1621

E-Mail: [sales@newmarpower.com](mailto:sales@newmarpower.com)

## VIII) REFERENCE APPENDIX

- For more information about boat wiring to conform to U.S. Coast Guard regulations, write:

Superintendent of Documents  
Government Printing Office  
Washington, DC 20402

Request : 33 CFR 183 Subpart I

- For information about American Boat and Yacht Council recommendations for boat wiring, write to:

American Boat and Yacht Council  
3069 Soloman's Island Road  
Edgewater, MD 21037

Request: Standards and Recommended Practices for Small Craft.

AC systems: Section E8

DC systems: Section E9

A-20: Battery Charging Devices

A-25: Inverters

- For additional installation instructions, refer to:  
ANSI NFPA 302

