

Engine Monitor

Model: VOTT

Installation/Operation Manual



D) Wiring

The VOTT comes with a 33 inch length six conductor cable with a Deutsch connector # DT04—6P attached.

The VOTT will operate from 9.5 to 33.0 vdc input. It displays data via the J1939 CAN Bus.

Meter Deutsch connector pin ID is:

Pin	Signal	Wire Color
1	+9.5-33.0 vdc Power.....	Red
2	Power/Signal Ground.....	Black
3	J1939+.....	Yellow
4	J1939-.....	Green
5	External buzzer 12 vdc alarm output: +..	White
6	External buzzer 12 vdc alarm output: - ..	Blue

2) Mounting:

The VOTT requires a 2-1/8" diameter round hole for mounting. The meter comes with a aluminum U shaped mounting bracket and #8-32 nuts and lock washers to secure bracket, see Figure 1.

FIGURE 1: Mounting

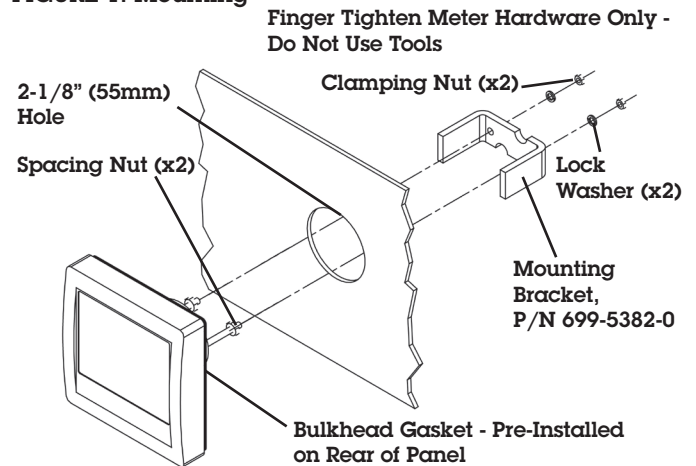

3) Menu Navigation & Calibration

A) Main Page

When the instrument is powered up it displays the "Main" page. The "Main" page displays: ENGINE RPM, OIL PSI, ENGINE TEMP F (or C), and BATT VOLTS. Values are displayed in GREEN if within acceptable alarm set limits or RED if out of limits condition exists.

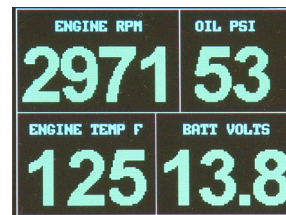

NEWMAR
DC Power Onboard
Emergency & Specialty Vehicles

M-VOTT
As of June 2012

From MAIN PAGE display:

- Pressing the ▲ key for ½ second (longer than a quick press but shorter than 2 seconds) will cause a white ALARM bell symbol to be displayed and enable the alarms.
- Pressing the ▼ key for ½ second (longer than a quick press but shorter than 2 seconds) will disable the alarms and remove the white alarm bell symbol.
- Press the "+" key momentarily while an alarm condition exists will silence the audible and external alarm as indicating by Red "X"

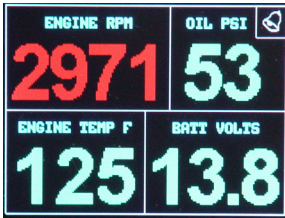

- Pressing the + key for ½ second (longer than a quick press but shorter than 2 seconds) will increment the backlight level through four different intensities.

4) Menu Tree

Press "*" key to bring up:

A) Secured Access Pages

While in the Main page, a Quick press of the * key brings up the Security Access page and a default number 5000 is displayed in the ACCESS CODE box.

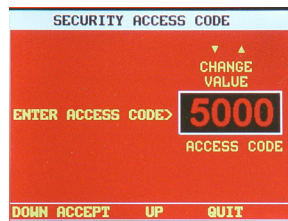

Use the ▲ and ▼ keys to scroll to the correct access code and press "ACCEPT" to enter that number (default ACCESS CODE is 1234). The longer you hold down the ▲ or ▼ key, the faster the scrolling of numbers. False entry results in Main Page being displayed. Entry of correct access code unlocks the instrument and brings up the following menu:

- B)** If access approval achieved then this page is displayed:
- ALARMS
 - SETUP
 - DETAILS
 - ABOUT

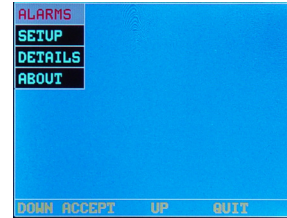

ALARMS Menu:

- BATT VOLTS HI
- BATT VOLTS LO
- OIL PRESSURE HI
- OIL PRESSURE LO
- ENGINE TEMP. HI
- ENGINE RPM HI
- <-- BACK

Alarm Ranges:

Engine RPM: 0000 - 9999 is set to 1300 (whole numbers only)

Oil Pressure: Low/High settable to 00 - 99 (whole numbers only)

Engine Temp: High settable to 100 - 250

Battery Volts: Low/High settable to 9.0 - 33.0



SETUP MENU:

- ACCESS CODE
- USE DEG C/BARS (or USE DEG F/PSI)
- RESET MIN/MAX VALUES (See Details page)
- <-- BACK

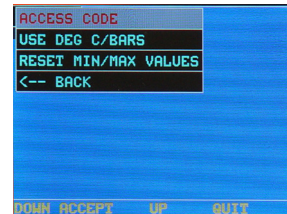

Access Code Setting

If no key has been pressed for 60 seconds from any of the menus or submenus, the instrument will revert to displaying the Main Page.

The ACCESS CODE is required to access alarm settings, and instrument setup menus. Set the ACCESS CODE to a number from 0000 to 9999 by using the ▲ or ▼ keys then press the + key to accept. The factory default is set to 1234.

If the ACCESS CODE is ever forgotten, the instrument can be reset back to factory default. Reset to "Factory Defaults" by pressing and holding the ▲, "+", ▼ keys while applying DC power. Answer "Yes" by pressing

NEWMAR
DC Power Onboard
Emergency & Specialty Vehicles

key labeled "Yes". This will reset password to 1234.
 Caution: Resetting to factory default will reset all alarm settings as well.

DETAILS: Displays details page. SN, Min/Max, Alarm Values, etc.

DETAILS	
SERIAL NUMBER: 111003002	UNITS
ACCESS CODE: 4999	DEC F
INSTRUMENT HOURS: 1.1	PSI
DC VOLTS ALARM HI: 16.0 LO: 11.3	
OIL PRESS ALARM HI: 75 LO: 9	
ENG. TEMP. ALARM HI: 224	
RPM ALARM HI: 3500	
OIL PRESSURE MAX: 99 MIN: 2	
BATT. VOLTS MAX: 99.9 MIN: 13.8	
MAX RPM: 8031	MAX TEMP: 410
BACK BACK	BACK QUIT

ABOUT : Displays Newmar splash screen, SWVer, HwVer and Copyright notice.

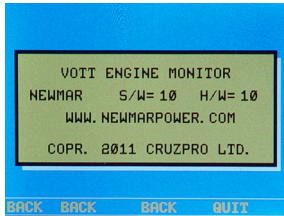

Additional meter operation information:

- Low Oil Pressure only updated if Rpm>100 (i.e. engine running)
- Battery Voltage limited to 99.9 (only 3 digits for display)
- Oil Pressure limited to 99 PSI (only 2 digits for display)
- Engine Temperature 32 deg F (0 deg C) minimum (don't want to have to deal with negative numbers when in Deg C)
- MaxRpm only updated if Rpm > MaxRpm+10 (help prevent exceeding max number of Flash writes)
- "LOST COMM" message displayed if no J1939 data received for 10 or more seconds. Restore display on valid data or any key press
- A press of any button activates/restarts 5 minute alarm "silence" timer
- Don't allow INSTRUMENT hours to increment in Sleep mode

VI) Specifications

Power Supply: 9.50 to 33.00 VDC, @ 80mA
Operating Temperature: 32° to 122° F (0° to 50° C)
Size: 4.3" x 4.3" x 3.5" deep (110 x 110 x 89 mm).
Display Data:

Engine RPM: 0000 - 9999 (or as provided by J1939) On screen title "ENGINE RPM"
Oil Pressure: 0 - 99 PSI (or as provided by J1939) On screen title "OIL PSI" (factory default). User selectable for Millibars or European standard. On screen title "MBRS"
Engine Temp: 100 - 250° F (or as provided by J1939) On screen title "ENGINE TEMP F" (factory default). User selectable for Centigrade, on screen title "ENGINE TEMP C"
Battery Volts: 9.5 - 33.0 On screen title "BATT VOLTS"

Displays "COMM LOSS" & red dashes with loss of J1939 data. No alarm on COMM LOSS
Accuracy: Battery Volts: As provided by J1939
 Engine RPM: As provided by J1939
 Engine Temperature: As provided by J1939
 Oil Pressure: As provided by J1939

Supplied Transducers: Voltage (1 each) and Current transformers (2 each)

Alarms: Engine RPM, Low/High Oil Pressure, High Engine Temp, and Low/High Battery Volts

Alarm Output: 12 VDC, 50 mA max.



DC Power Onboard
Emergency & Specialty Vehicles